

GENERAL NOTES:

1. Chart is intended for reference only. Changes to frames or glazing options are frequently occurring.
2. Profiles are shown as double rabbet for illustration purposes only. Single rabbet frames are available with door side face sizes same as double rabbet.
3. Profiles are shown for basic information only. They are not intended for use as submittal drawings.
4. All frames are for use in positive pressure (UL-10C) or neutral pressure (UL-10B) conditions.
5. All frames are series F.
6. All stop height are 5/8" based on using listed glass, glazing, and glazing installation combinations.
7. Panels and glazing shown on door side for illustration purposes only. Panels and glazing may also be located opposite the door side to suit architectural details.
8. All transom bars and mullions are welded (non-removable).
9. ** ⓐ anchor column indicates that this anchor type is allowed up to 10'-0" overall height. Anchor must be welded to frame.

U.L. TRANSOM FRAMES

L-14 · MAR 2014

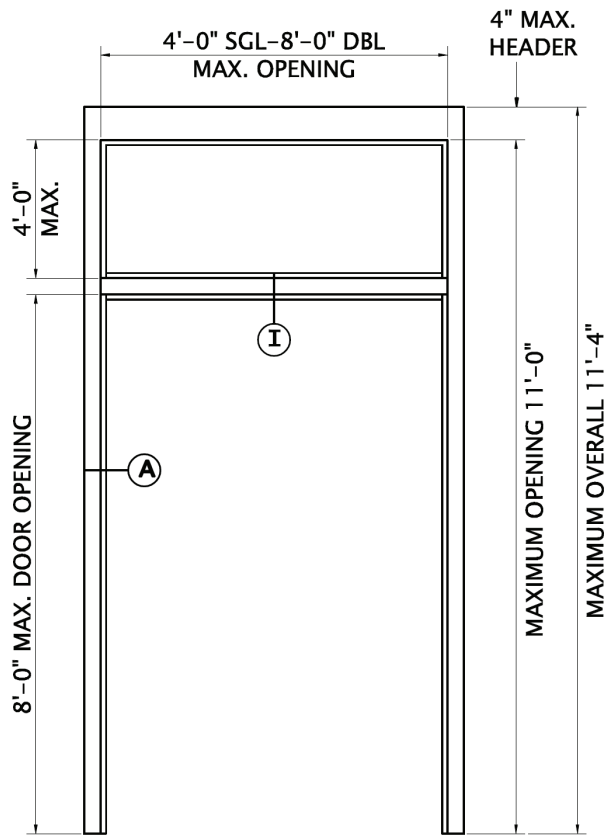

T1

1 3/4" Steel Stiffened Hollow Metal Panel

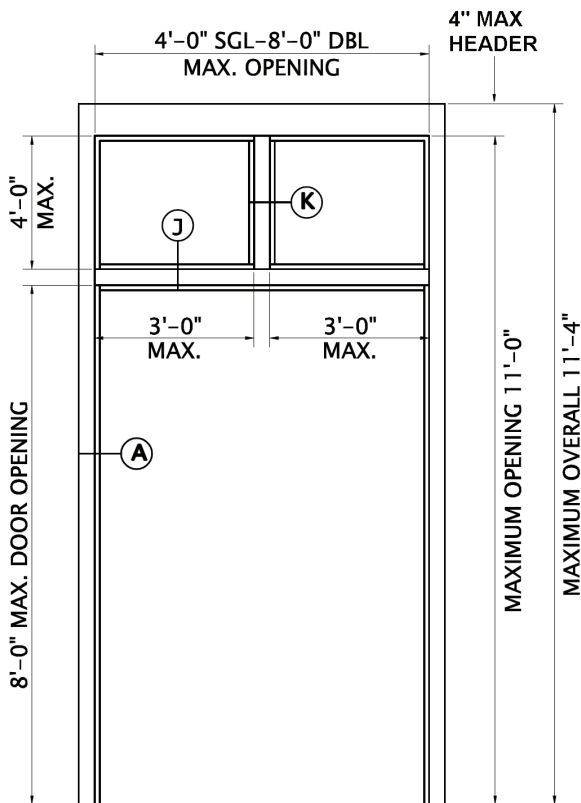

T2

3/8" Thick Laminate Panel.
3'-0" x 4'-0" Maximum Opening

U.L. TRANSOM FRAMES

L-15 · MAR 2014

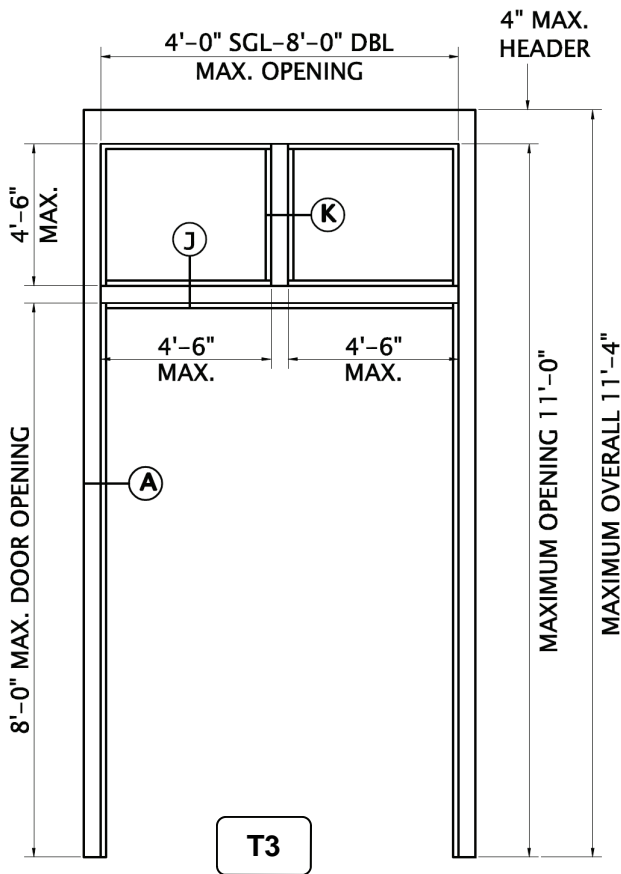

Fire Lite used with listed glazing material combinations. 4'-6" maximum width or height not to exceed 2,721 square inches exposed light.

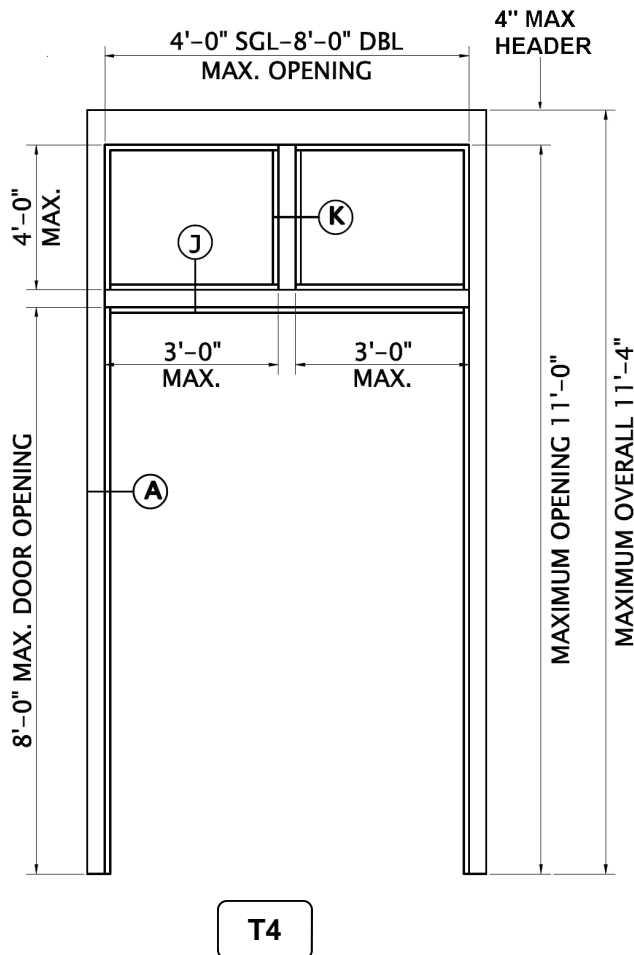

1/4" Wire glass used with listed glazing material combinations. 3'-0" maximum opening width or 4'-0" maximum opening height not to exceed 1,296 square inches exposed light.

U.L. TRANSOM FRAMES

L-16 · MAR 2014

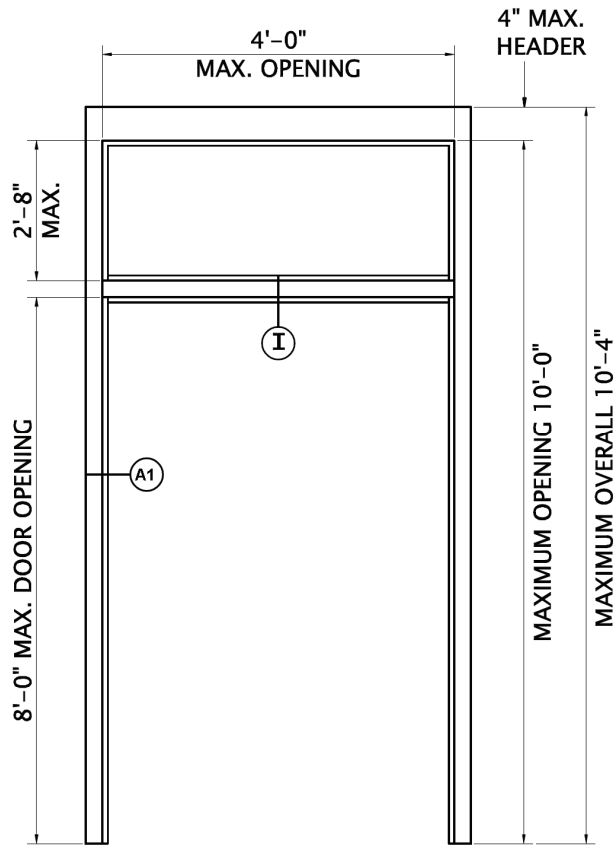

T5

1 3/4" Thick Composite Panel with steel faces, non-removable.

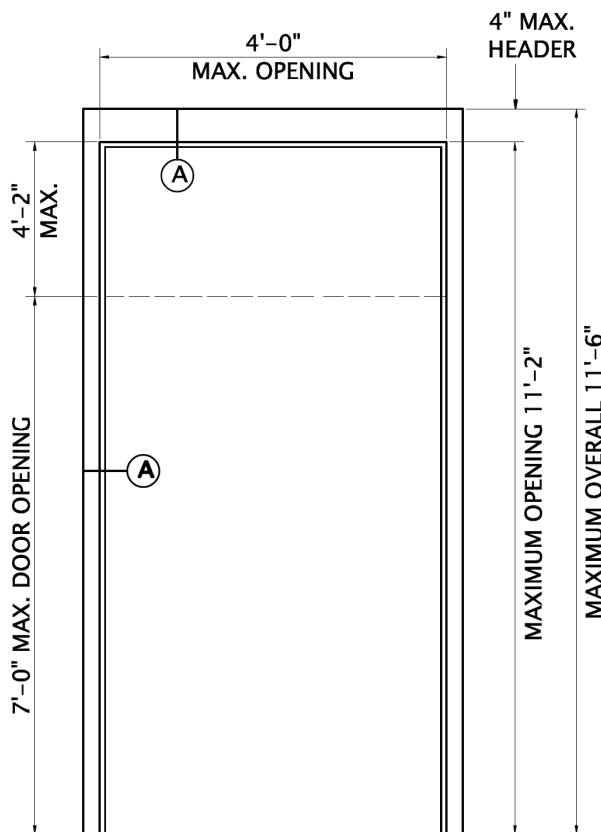

T6

1 3/4" Thick Honeycomb Core Panel non-removable.



MESKER™
The newest innovations in hollow metal from the oldest hollow metal door company in America

U.L. TRANSOM FRAMES

L-17 · MAR 2014

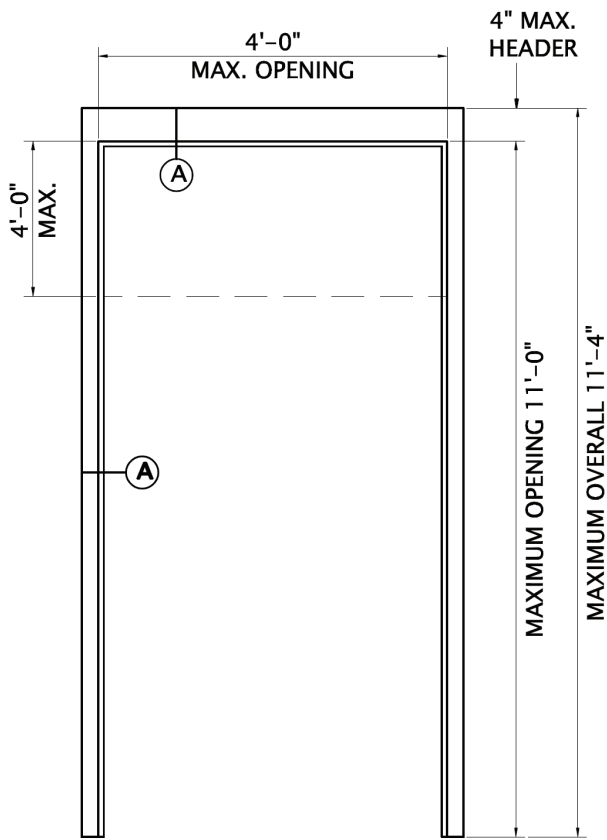

T7

1 3/4" Wood Panel with spring bolts non-removable.

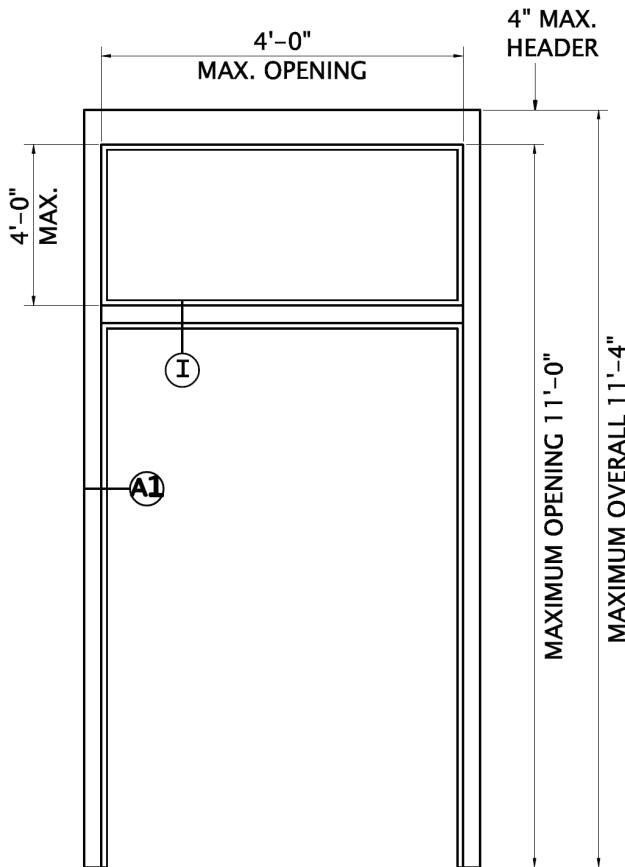

T8

1 3/4" Wood Panel with spring bolts non-removable.

U.L. TRANSOM FRAMES

L-18 · MAR 2014

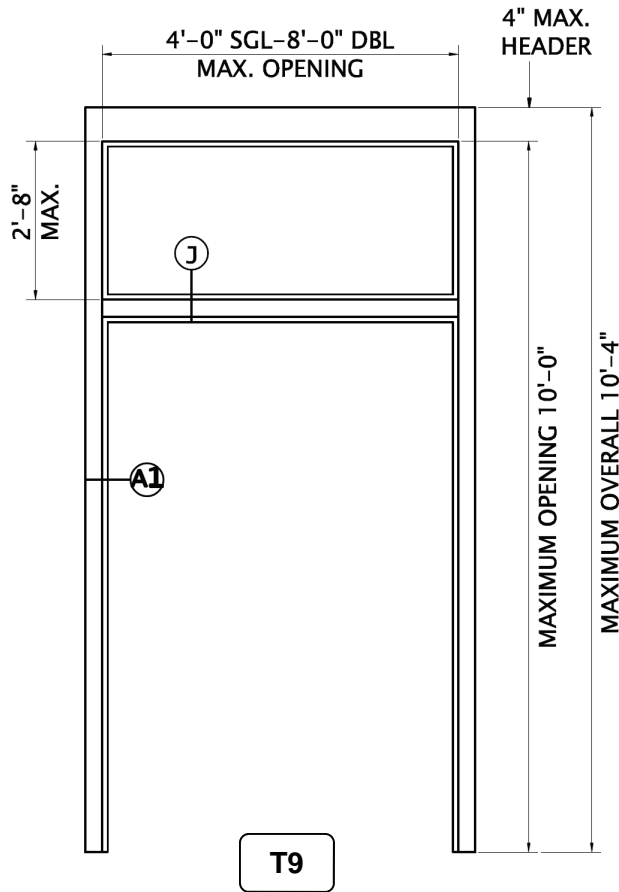

3/8" Cement Board Panel
non-removable.

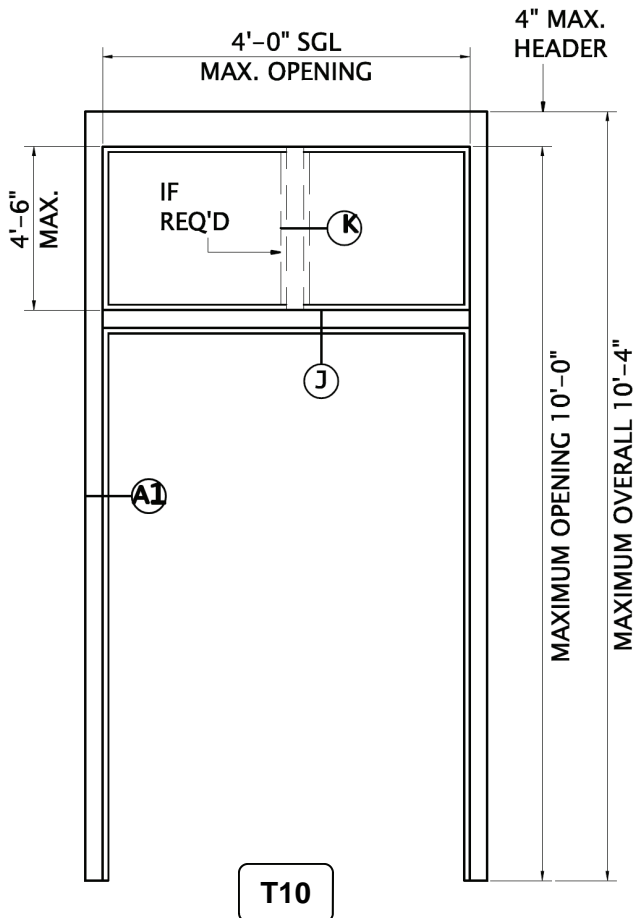

1/4" Wire glass. 4'-6" maximum opening
not to exceed 1,296 square inches
exposed light with conventional glazing
systems and 3/4" high stops at
transom.

See Elevation T4 for optional
information in lieu of this design.

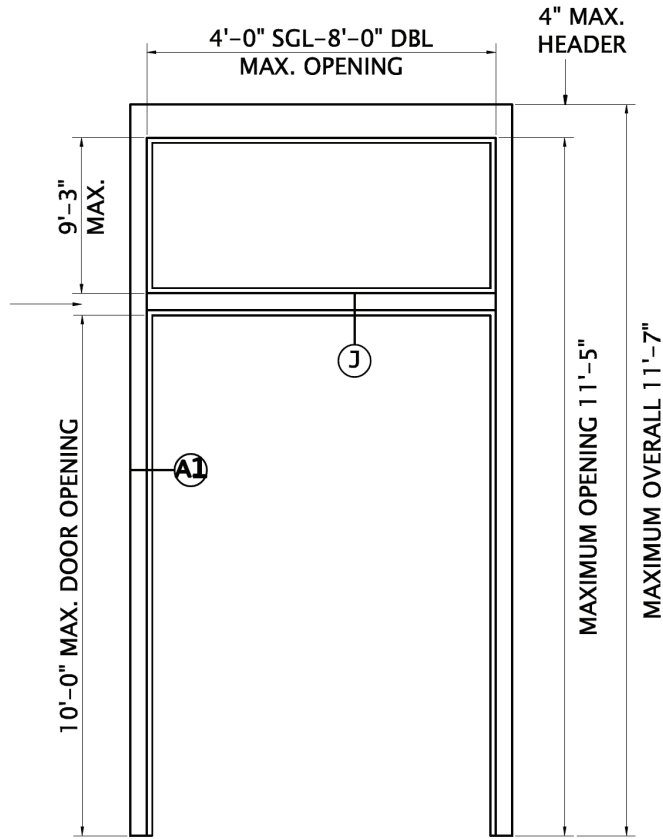

T11

1/4" Listed glazing material combinations up to 9'-3" opening width or height not to exceed 5,268 square inches exposed light.

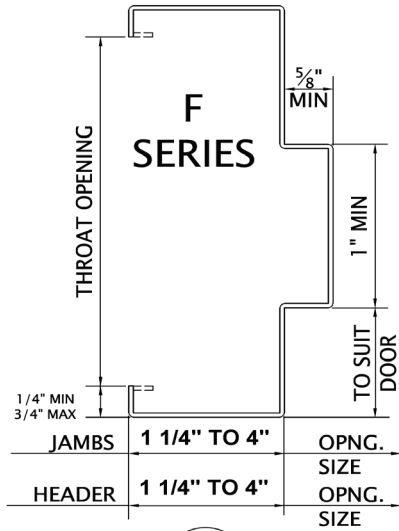

A

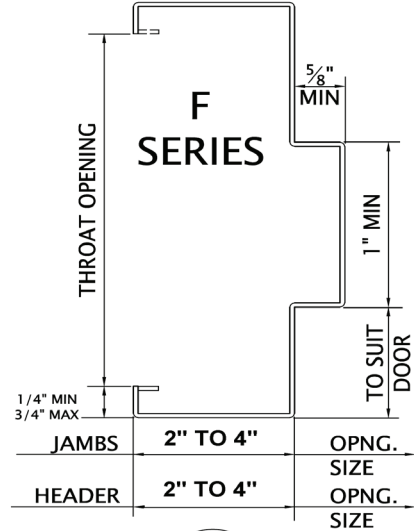

A1

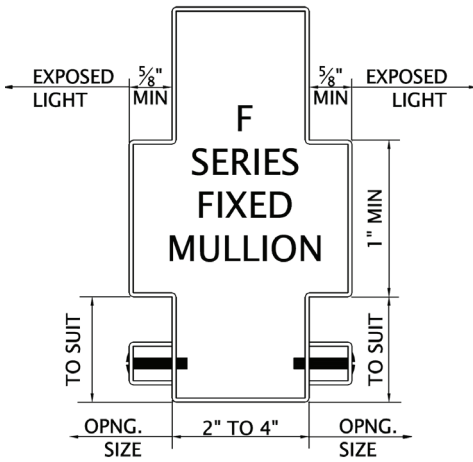

K

MULLION WELDED AT BOTH FACES

NOTE: DOUBLE RABBET PROFILE RECOMMENDED FOR ASTHETICS

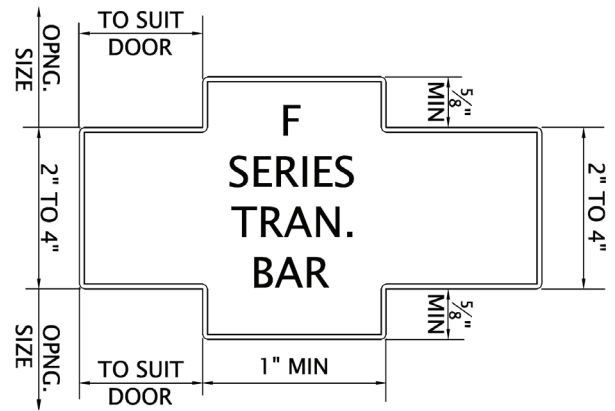

I

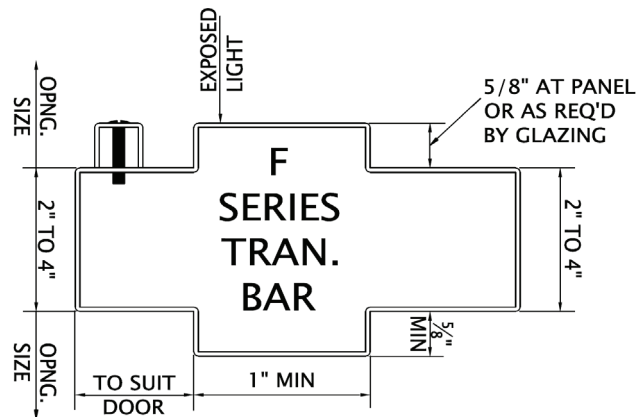

J



MESKER™

The newest innovations in hollow metal from the oldest hollow metal door company in America