

WIRE

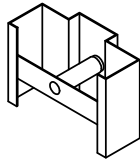

TUBE

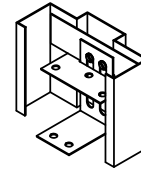

**ADJUSTABLE
FLOOR**

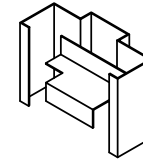

ZEE

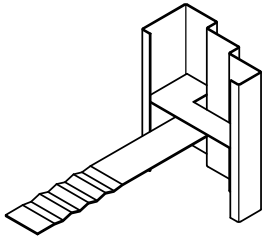

**DOUBLE
EGRESS
T**

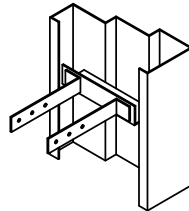

**DOUBLE
EGRESS
MULTI PURPOSE**

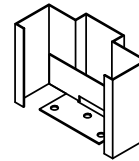

FLOOR

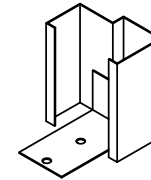

SINGLE FLOOR

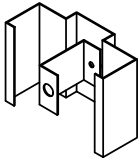

AEW

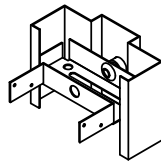

UNA

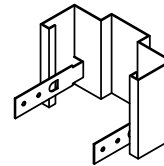

**DRYWALL
OPTION**

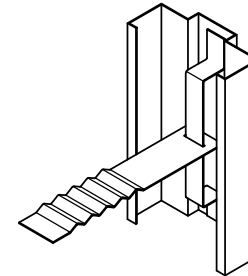

STRAP

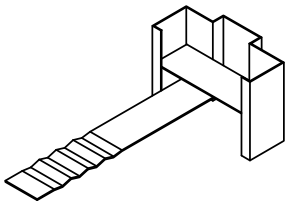

T

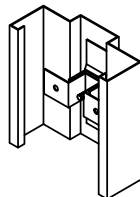

DRYWALL

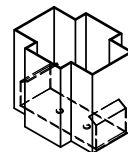

MULLION

MESKER™

SUB-XX

DRAWN BY _____ DATE _____		ISSUE DATE	REVISIONS	BY
CHECKED _____ DATE _____				
SHT OF	JOB NO.			

① TOP CHANNELS

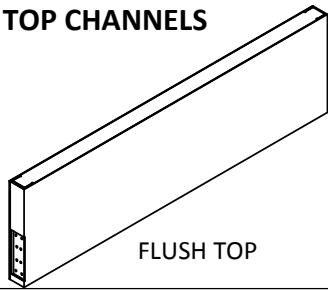

FLUSH TOP

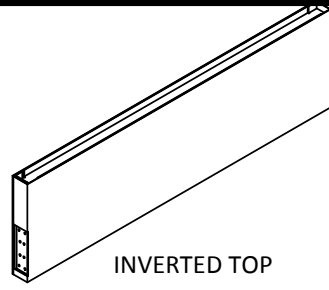

INVERTED TOP

② CLOSER REINFORCEMENT

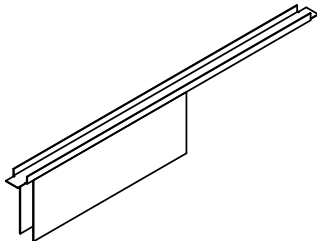

③ VERTICAL EDGE

STANDARD

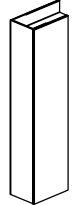

NVS

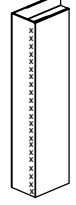

④ HINGE PREP

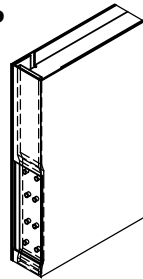

⑤ CORE

POLYSTRENE

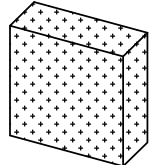

⑥ LOCK EDGE

BEVELED EDGE



SQUARE EDGE



⑦ LOCK PREP

FOR LOCK PREPS
SEE DOOR PREP PAGE

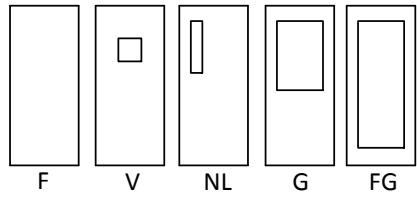

MUST HAVE BULLET RATED GLASS.

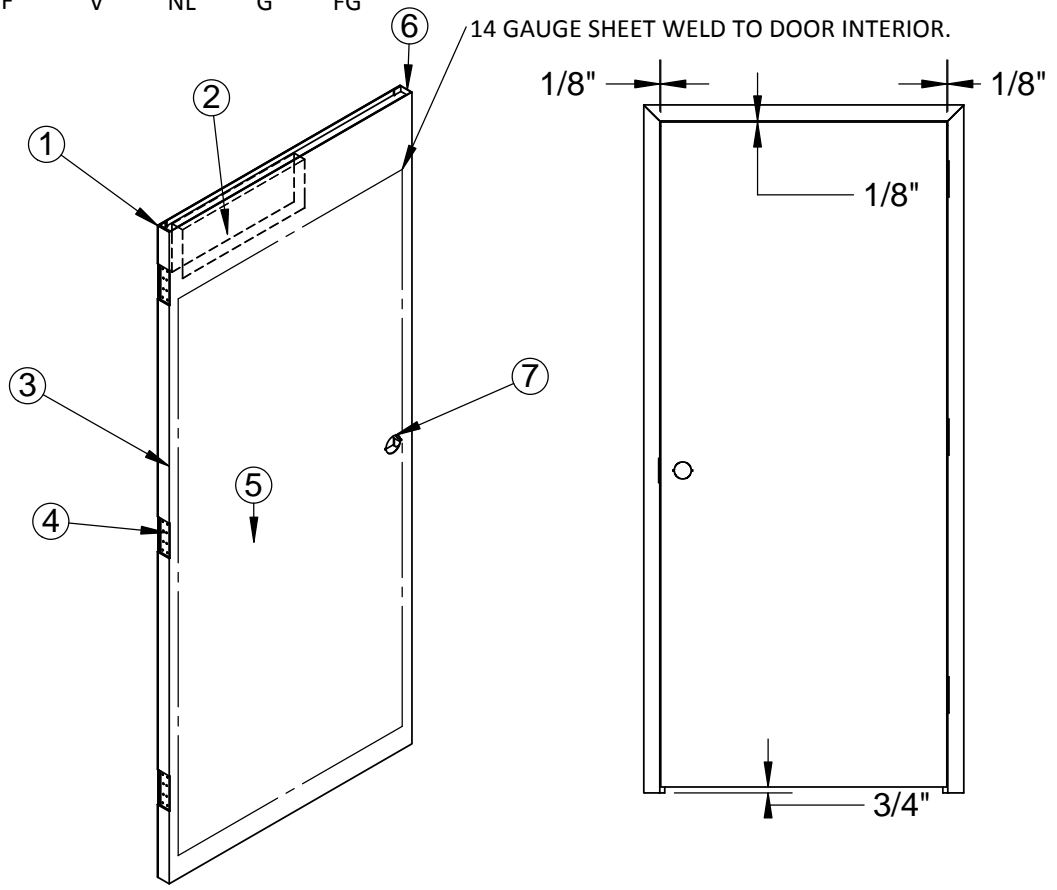

BULLET ASSEMBLY

DOOR MEETS OR EXCEEDS ANSI 250.4 PERFORMANCE TEST:

20 GAUGE STEEL (500,000 CYCLES)

18 & 16 GAUGE STEEL (1,000,000 CYCLES)

DOORS MEET LEED REQUIREMENTS AND BUY AMERICAN STANDARDS.

LABELING AGENCIES:
UNDERWRITES LABRATORY INC.
WARNOCK HERSEY INTL.
FACTORY MUTUAL SYSTEM

AVAILABLE IN:
14, 16, 18, 20
GAUGE
CR, A60



MESKER™		SUB-XX	
DRAWN BY _____ DATE _____		ISSUE DATE	REVISIONS
CHECKED _____ DATE _____			BY
SHT OF	JOB NO.		

**FLUSHBOLT PREP
WITH ASTRAGAL**

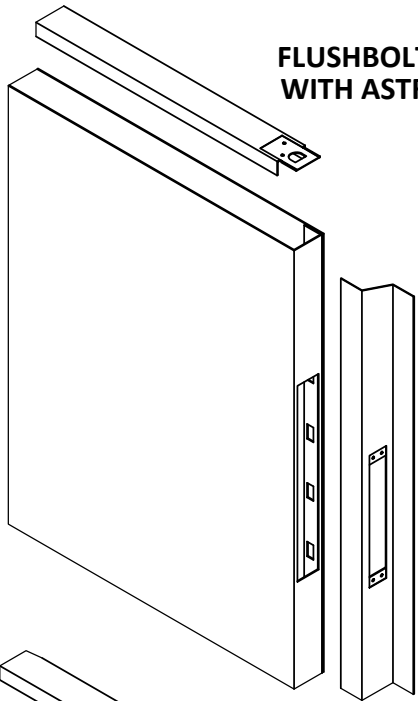

**FLUSHBOLT PREP
WITHOUT ASTRAGAL**

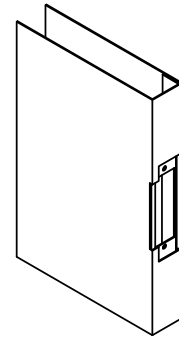
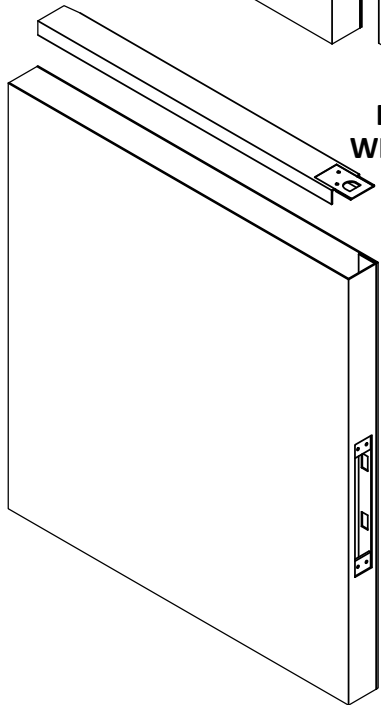

U STRIKE PREP

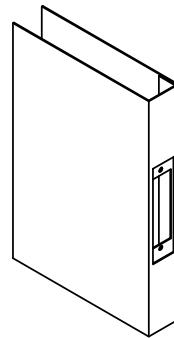

**NON HANDED
STRIKE**

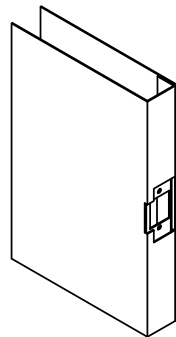

C STRIKE PREP

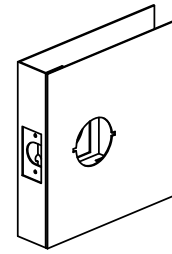

C4

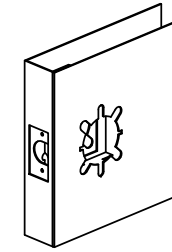

C4 TURTLE

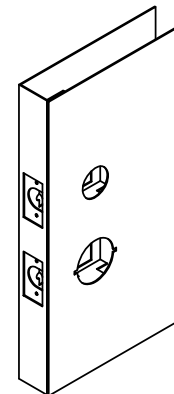

INTERCONNECTED

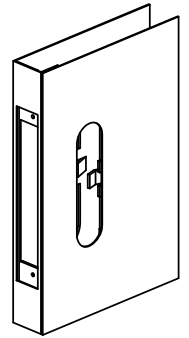

M

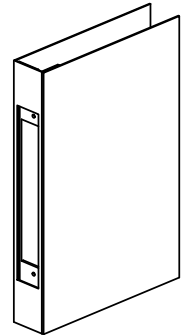

MB

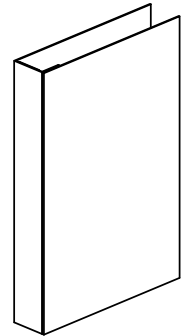

MBN

FOR ADDITIONAL DOOR PREPS, SEE THE
DOOR SECTION OF THE TECHNICAL DATA
MANUAL.

MESKER™

SUB-XX

DRAWN BY _____ DATE _____		ISSUE DATE	REVISIONS	BY
CHECKED _____ DATE _____				
SHT OF	JOB NO.			

OPENING HEIGHT	6'8"			7'0"			7'2"			7'10"			8'0"		
DIMENSION	A	B	C	A	B	C	A	B	C	A	B	C	A	B	C
1 3/4" DOOR SPACING	7 1/4"	2@ 30 1/4"	12 1/4"	7 1/4"	2@ 32 1/4"	12 1/4"	7 1/4"	2@ 33 1/4"	12 1/4"	7 1/4"	3@ 25 1/4"	10 1/4"	7 1/4"	3@ 25 1/2"	12 1/4"
1 3/4" DOOR SPACING				6 3/4"	2@ 32 3/4"	11 3/4"	6 3/4"	2@ 33 3/4"	11 3/4"						

HINGE SPACING

PROFILE

F SERIES

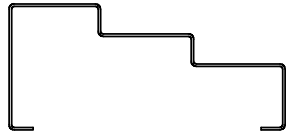

FDJ SERIES

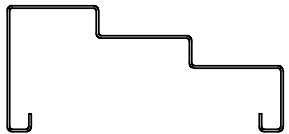

HEADER JUNCTION ON A DOUBLE SWING OPENING

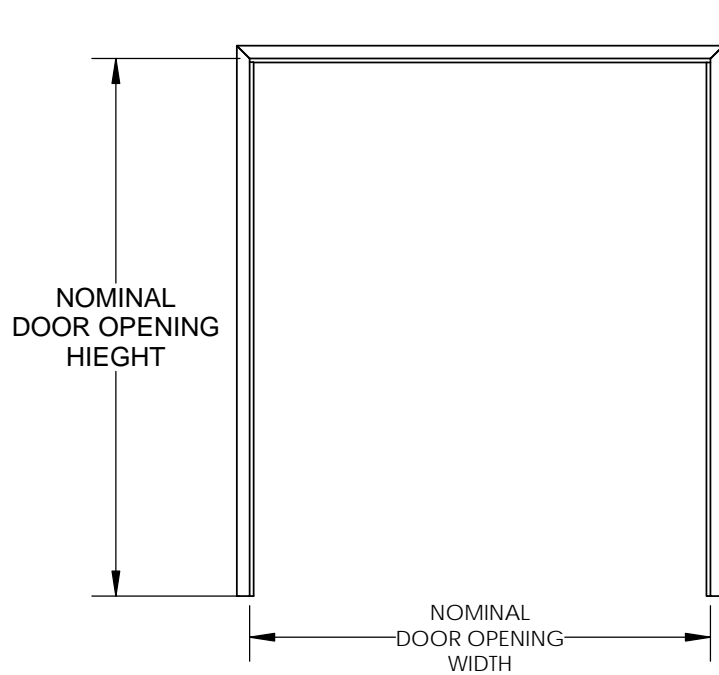
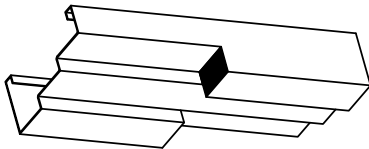

DOUBLE SWING

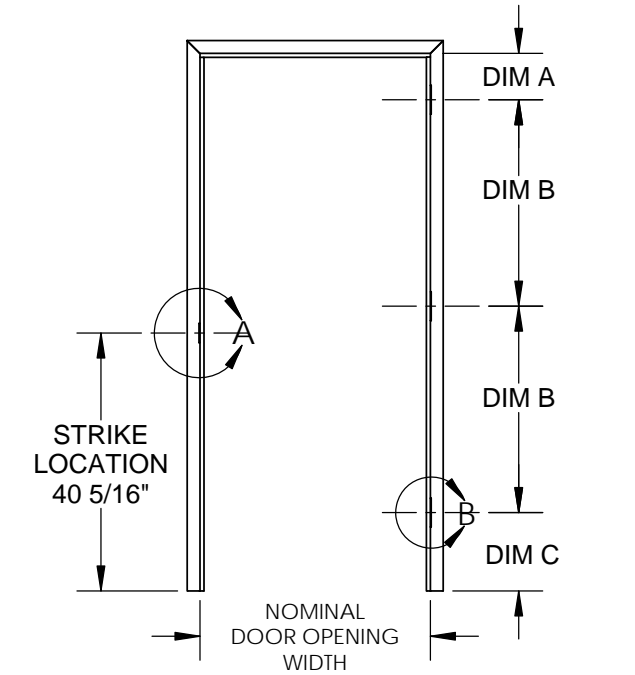

SINGLE SWING

DOUBLE EGRESS FRAMES

F SERIES FRAMES ARE AVAILABLE AS SHOWN FOR THREE SIDED FRAMES OR AS STICK SECTIONS FOR TRANSOMS, SIDELIGHTS AND BORROWED LIGHT FRAMES.

FOR ANCHORS SEE ANCHOR PAGE

FOR LABELING DETAILS SEE THE LABELING SECTION.

FOR DOOR HANDING AND SWING SEE THE GENERAL SECTION



SUB-XX

DRAWN BY _____ DATE _____		ISSUE DATE	REVISIONS	BY
CHECKED _____ DATE _____				
SHT OF	JOB NO.			

PROFILES

DOUBLE RABBET

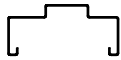

SINGLE RABBET



CASED OPEN



DOUBLE EGRESS

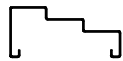

HOSPITAL STOP

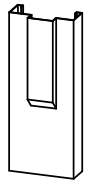

WELD OPTIONS

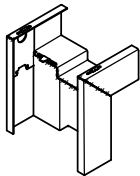

FULL WELD

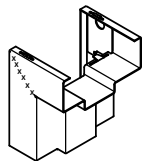

FACE WELD

CORNER SECTION

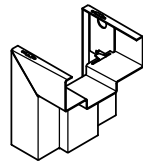
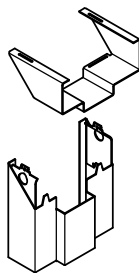

FDJ ANCHORING

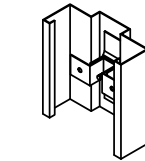

COMPRESSION ANCHOR

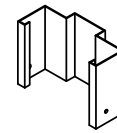

BASE ANCHOR DIMPLES

HINGE SPACING

OPENING HEIGHT	6'8"			7'0"			7'2"			7'10"			8'0"		
DIMENSION	A	B	C	A	B	C	A	B	C	A	B	C	A	B	C
1 3/4" DOOR SPACING	7 1/4"	2@ 30 1/4"	12 1/4"	7 1/4"	2@ 32 1/4"	12 1/4"	7 1/4"	2@ 33 1/4"	12 1/4"	7 1/4"	3@ 25 1/4"	10 1/4"	7 1/4"	3@ 25 1/2"	12 1/4"
1 3/8" DOOR SPACING				6 3/4"	2@ 32 3/4"	11 3/4"	6 3/4"	2@ 33 3/4"	11 3/4"						

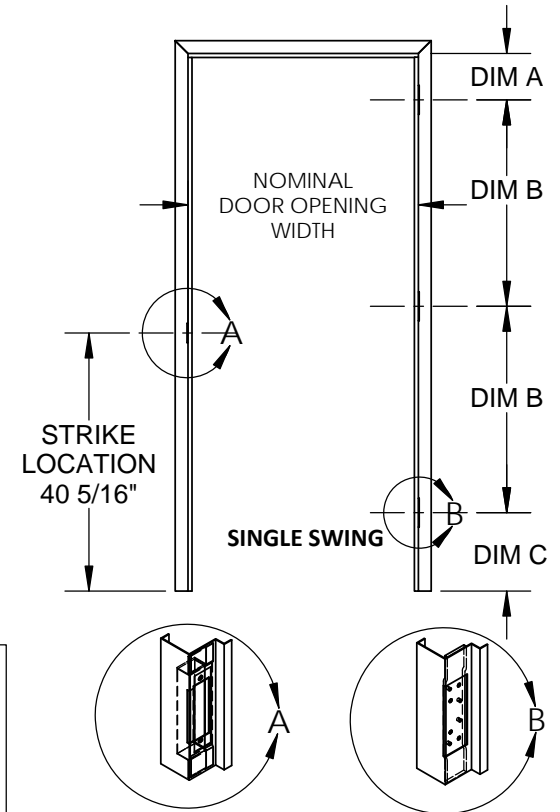
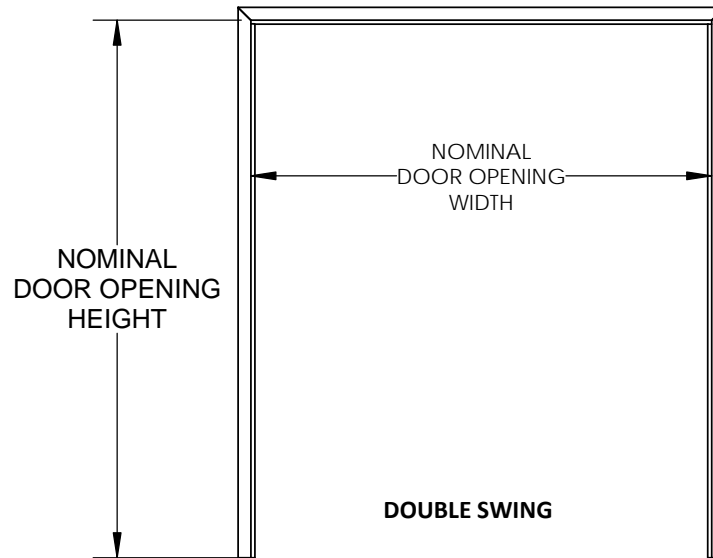

FDJ SERIES FRAMES

FDJ SERIES FRAMES ARE AVAILABLE AS SHOWN FOR THREE SIDED FRAMES OR AS STICK SECTIONS FOR TRANSOMS, SIDELIGHTS AND BORROWED LITE FRAMES.

FOR LABELING DETAILS, ANCHORING OPTIONS, AND DOOR HANDING & SWING, PLEASE SEE THE APPLICABLE SECTION OF THE TECHNICAL DATA MANUAL.



SUB-XX

DRAWN BY _____ DATE _____		ISSUE DATE	REVISIONS	BY
CHECKED _____ DATE _____				
SHT OF	JOB NO.			

PROFILES

DOUBLE RABBET

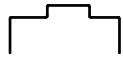

SINGLE RABBET



CASED OPEN

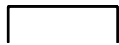

HINGE SPACING

OPENING HEIGHT	6'8"			7'0"			7'2"			7'10"			8'0"		
	A	B	C	A	B	C	A	B	C	A	B	C	A	B	C
1 3/4" DOOR SPACING	7 1/4"	2@ 30 1/4"	12 1/4"	7 1/4"	2@ 32 1/4"	12 1/4"	7 1/4"	2@ 33 1/4"	12 1/4"	7 1/4"	3@ 25 1/4"	10 1/4"	7 1/4"	3@ 25 1/2"	12 1/4"
1 3/8" DOOR SPACING				6 3/4"	2@ 32 3/4"	11 3/4"	6 3/4"	2@ 33 3/4"	11 3/4"						

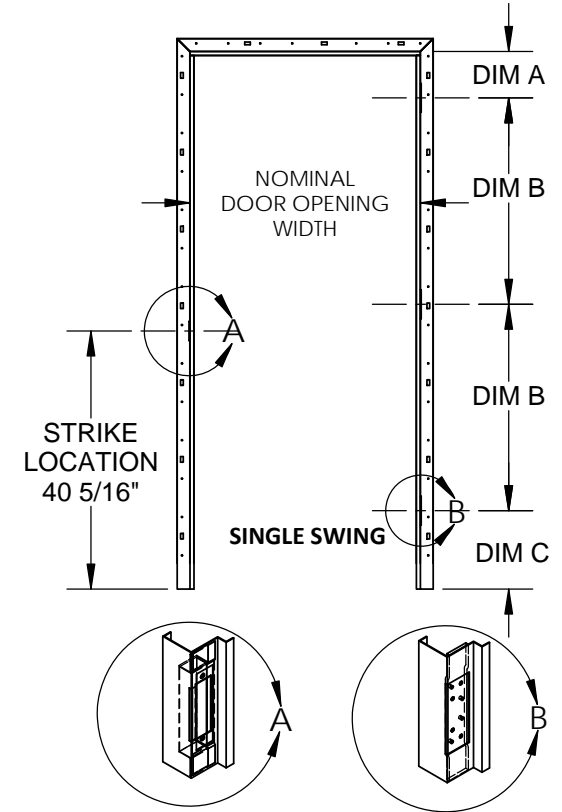
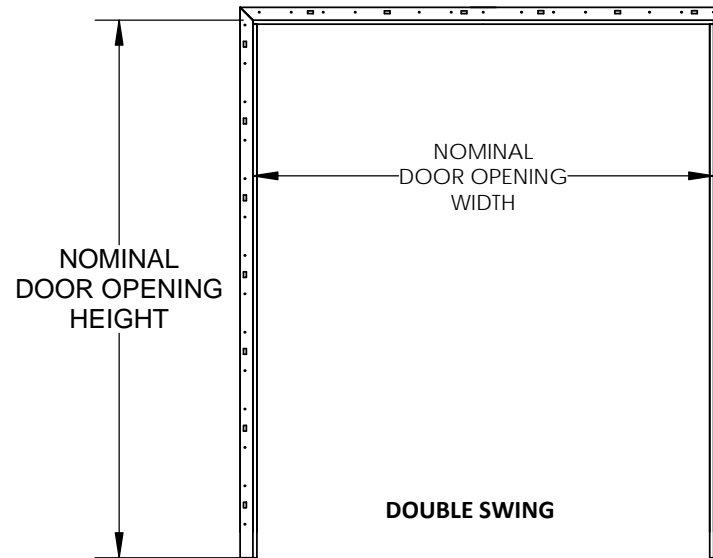

FF SERIES FRAMES

FF SERIES FRAMES ARE AVAILABLE AS SHOWN FOR THREE SIDED FRAMES OR AS STICK SECTIONS FOR TRANSOMS, SIDELIGHTS AND BORROWED LITE FRAMES.

FOR LABELING DETAILS, ANCHORING OPTIONS, AND DOOR HANDING & SWING, PLEASE SEE THE APPLICABLE SECTION OF THE TECHNICAL DATA MANUAL.



SUB-XX

DRAWN BY _____ DATE _____		ISSUE DATE	REVISIONS	BY
CHECKED _____ DATE _____				
SHT OF	JOB NO.			

PROFILES

DOUBLE RABBET

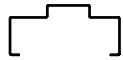

SINGLE RABBET



CASED OPEN

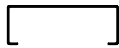

DOUBLE EGRESS

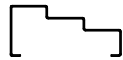

HOSPITAL STOP

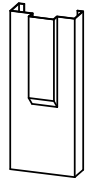

WELD OPTIONS

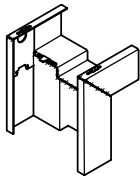

FULL WELD

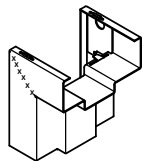

FACE WELD

CORNER SECTION

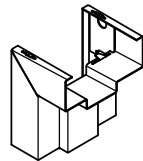
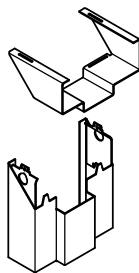

HINGE SPACING

OPENING HEIGHT	6'8"			7'0"			7'2"			7'10"			8'0"		
DIMENSION	A	B	C	A	B	C	A	B	C	A	B	C	A	B	C
1 3/4" DOOR SPACING	7 1/4"	2@ 30 1/4"	12 1/4"	7 1/4"	2@ 32 1/4"	12 1/4"	7 1/4"	2@ 33 1/4"	12 1/4"	7 1/4"	3@ 25 1/4"	10 1/4"	7 1/4"	3@ 25 1/2"	12 1/4"
1 3/8" DOOR SPACING				6 3/4"	2@ 32 3/4"	11 3/4"	6 3/4"	2@ 33 3/4"	11 3/4"						

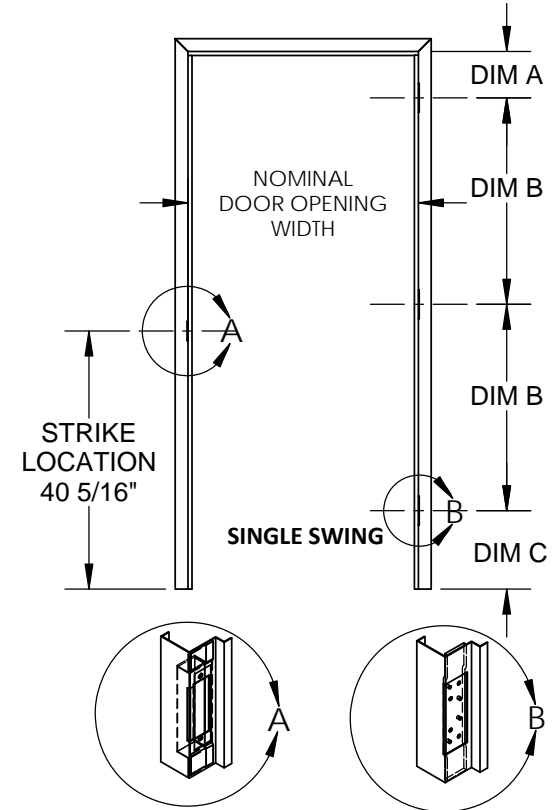
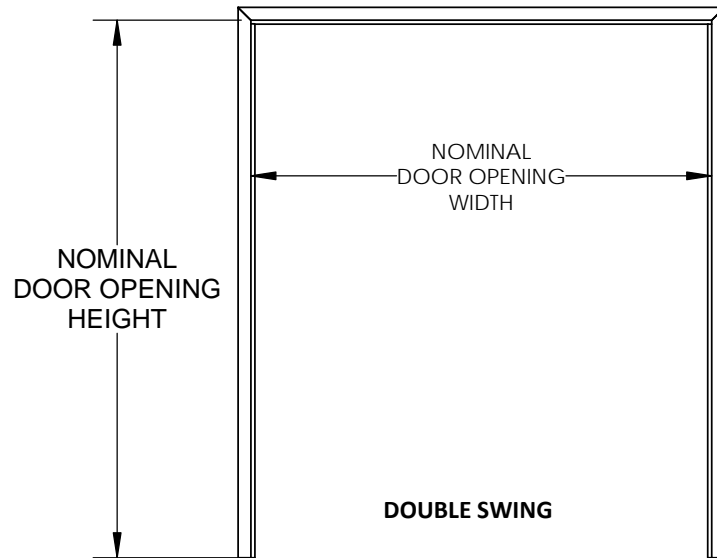

F SERIES FRAMES

F SERIES FRAMES ARE AVAILABLE AS SHOWN FOR THREE SIDED FRAMES OR AS STICK SECTIONS FOR TRANSOMS, SIDELIGHTS AND BORROWED LITE FRAMES.

FOR LABELING DETAILS, ANCHORING OPTIONS, AND DOOR HANDING & SWING, PLEASE SEE THE APPLICABLE SECTION OF THE TECHNICAL DATA MANUAL.



SUB-XX

DRAWN BY _____ DATE _____		ISSUE DATE	REVISIONS	BY
CHECKED _____ DATE _____				
SHT OF	JOB NO.			

① TOP CHANNELS

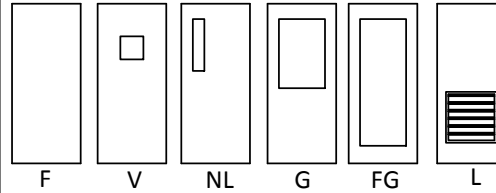
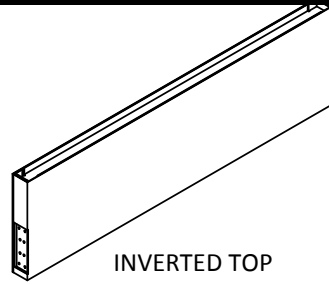
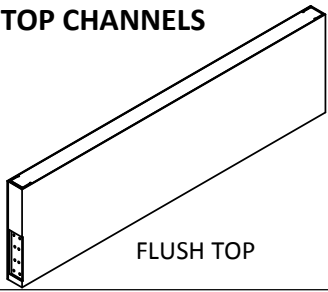

② CLOSER REINFORCEMENT

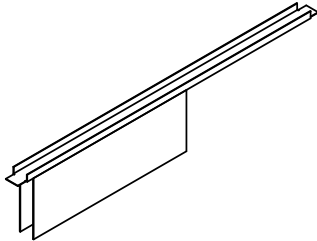

③ VERTICAL EDGE

STANDARD



NVS



④ HINGE PREP

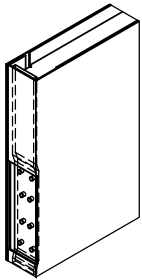

⑤ CORE

POLYSTRENE

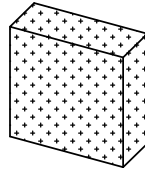

⑥ LOCK EDGE

BEVELED EDGE

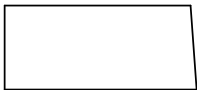

SQUARE EDGE



⑦ LOCK PREP

FOR LOCK PREPS
SEE DOOR PREP PAGE

DOOR MEETS OR EXCEEDS ANSI 250.4
PERFORMANCE TEST:

20 GAUGE STEEL (500,000 CYCLES)

18 & 16 GAUGE STEEL (1,000,000
CYCLES)

DOORS MEET LEED REQUIREMENTS
AND BUY AMERICAN STANDARDS.

LABELING AGENCIES:
UNDERWRITES LABRATORY INC.
WARNOCK HERSEY INTL.
FACTORY MUTUAL SYSTEM

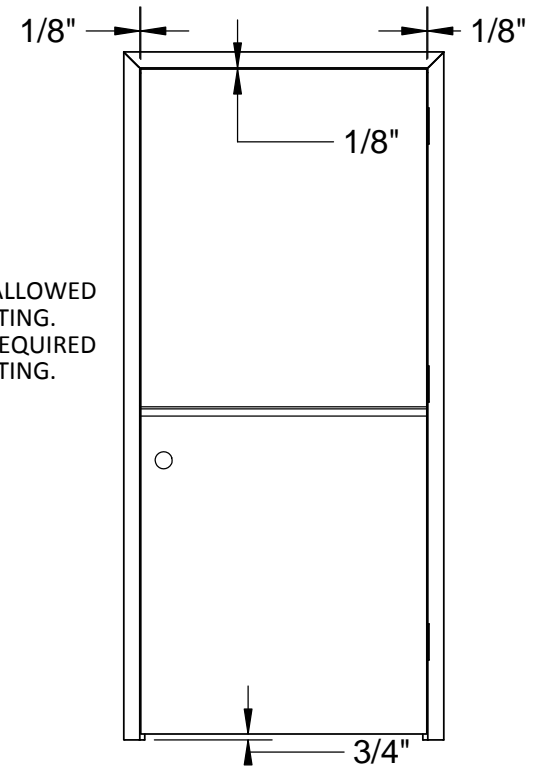
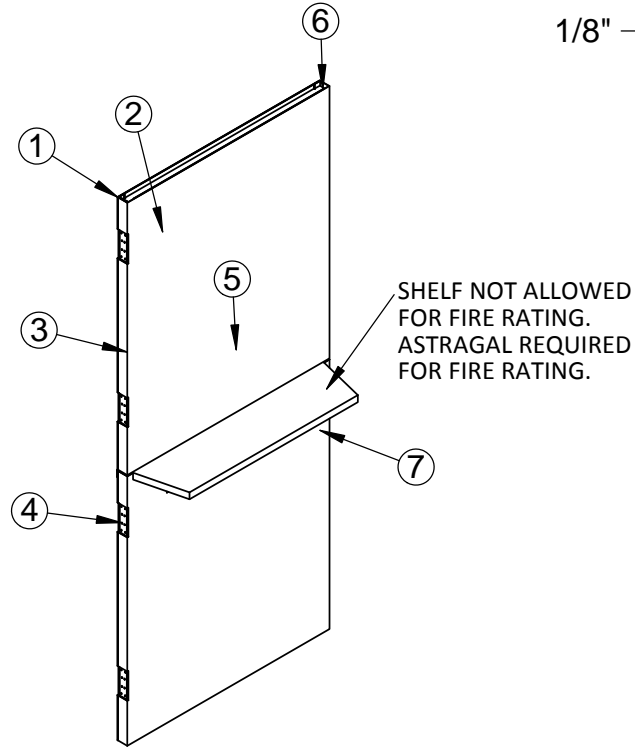

NDD SERIES DOOR
DUTCH DOOR

AVAILABLE IN:
14, 16, 18, 20
GAUGE
CR, A60



SUB-XX

DRAWN BY _____ DATE _____		ISSUE DATE	REVISIONS	BY
CHECKED _____ DATE _____				
SHT OF	JOB NO.			

① TOP CHANNELS

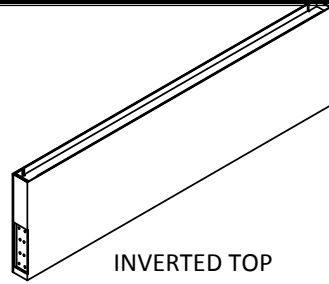
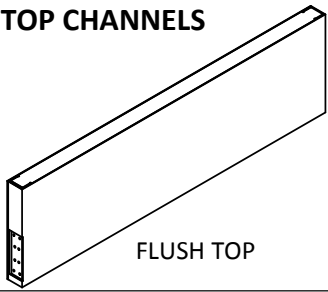

② CLOSER REINFORCEMENT

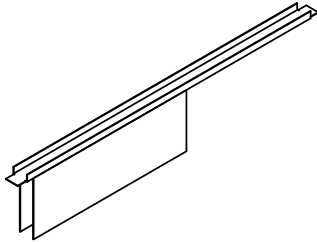

③ VERTICAL EDGE

STANDARD



NVS

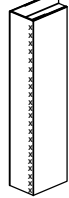

④ HINGE PREP

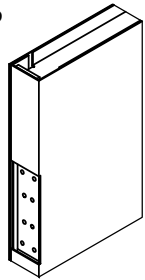

⑤ CORE

FIBER BOARD

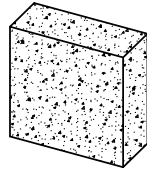

⑥ LOCK EDGE

BEVELED EDGE



SQUARE EDGE



⑦ LOCK PREP

FOR LOCK PREPS
SEE DOOR PREP PAGE

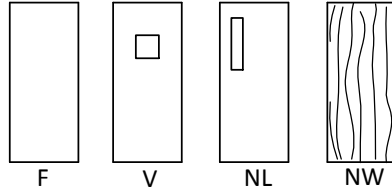

IF A TEMPERATURE RISE DOOR IS DESIRED, THEN ONLY 100 SQUARE INCHES OF GLASS ALLOWED.

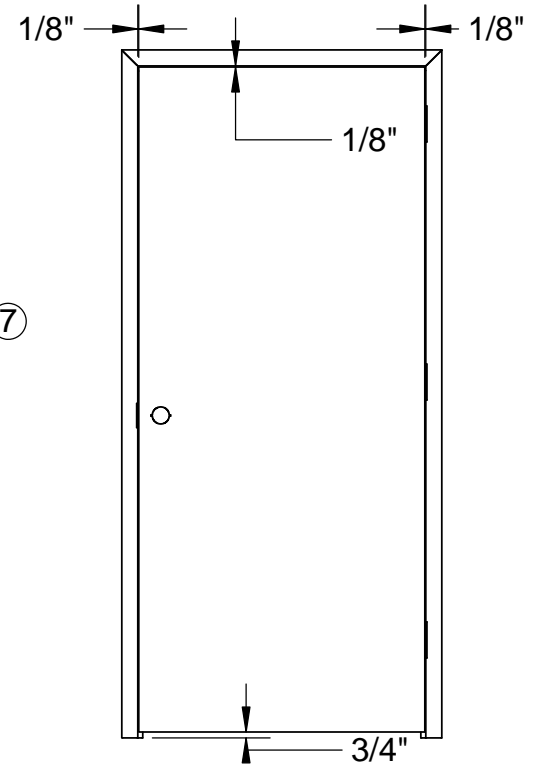
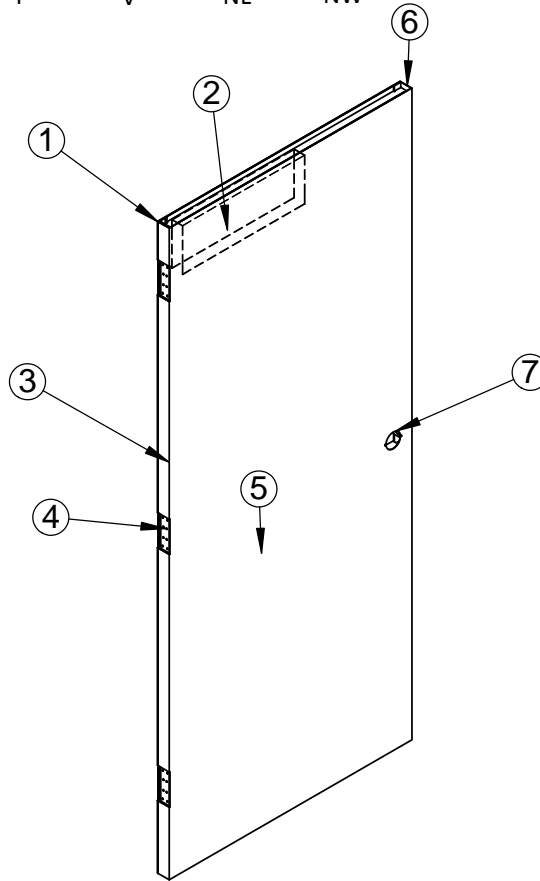

**NF SERIES DOOR
TEMPERATURE RISE (250)**

DOOR MEETS OR EXCEEDS ANSI 250.4 PERFORMANCE TEST:

20 GAUGE STEEL (500,000 CYCLES)

18 & 16 GAUGE STEEL (1,000,000 CYCLES)

DOORS MEET LEED REQUIREMENTS AND BUY AMERICAN STANDARDS.

LABELING AGENCIES:
UNDERWRITES LABORATORY INC.
WARNOCK HERSEY INTL.
FACTORY MUTUAL SYSTEM

AVAILABLE IN:
14, 16, 18, 20
GAUGE
CR, A60



SUB-XX

DRAWN BY _____ DATE _____		ISSUE DATE	REVISIONS	BY
CHECKED _____ DATE _____				
SHT OF	JOB NO.			

① TOP CHANNELS

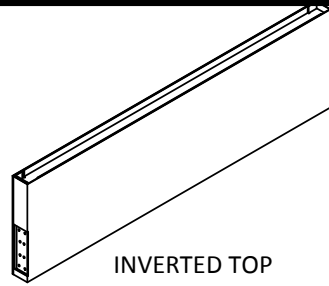
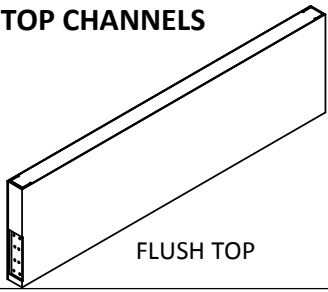

② CLOSER REINFORCEMENT

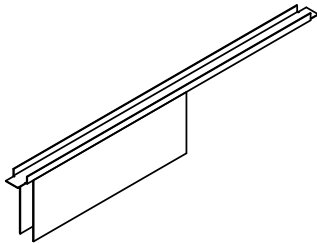

③ VERTICAL EDGE

STANDARD



NVS



④ HINGE PREP

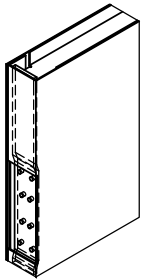

⑤ CORE

POLYSTRENE

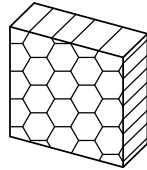

⑥ LOCK EDGE

BEVELED EDGE



SQUARE EDGE



⑦ LOCK PREP

FOR LOCK PREPS
SEE DOOR PREP PAGE

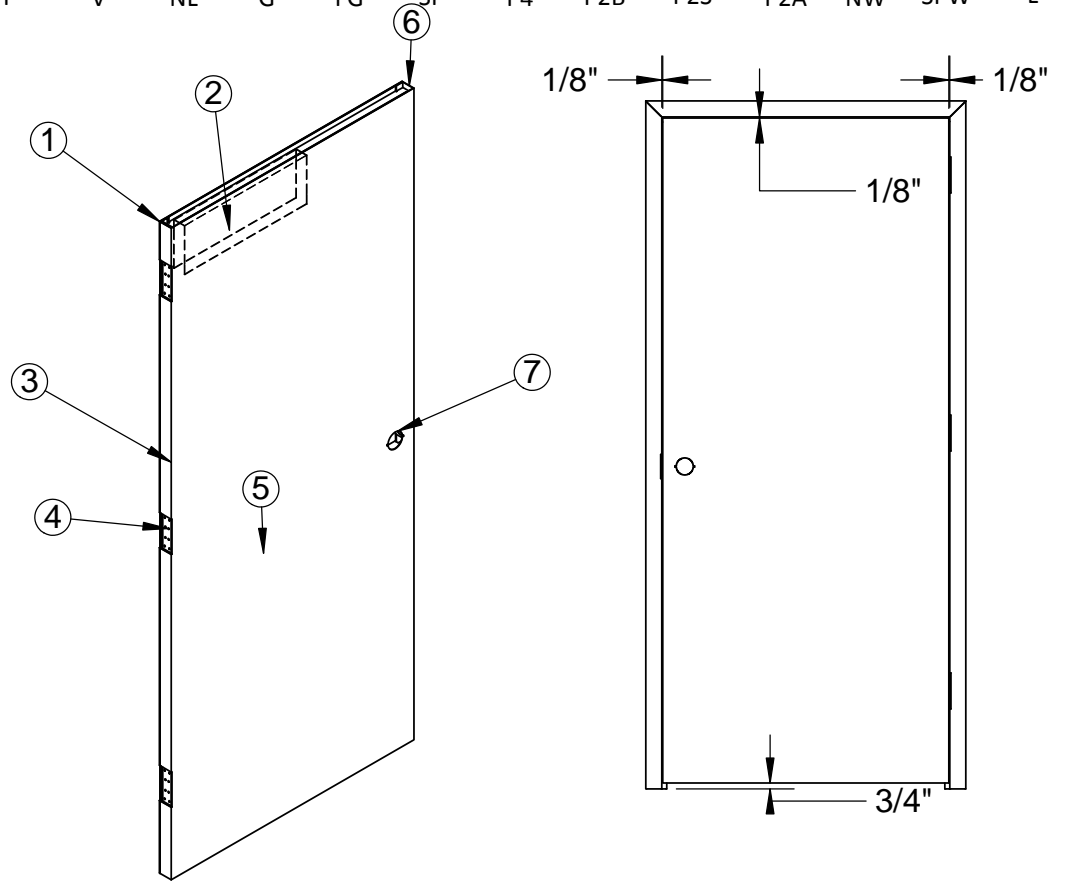
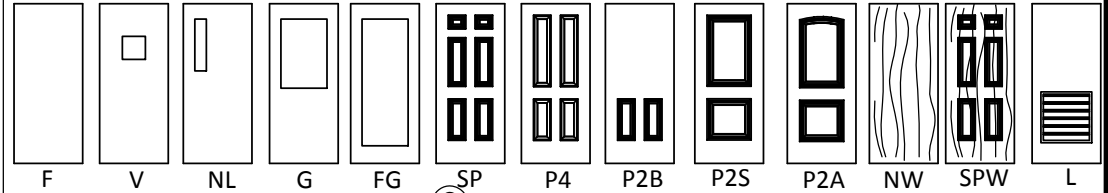

NH SERIES DOOR

DOOR MEETS OR EXCEEDS ANSI 250.4 PERFORMANCE TEST:

20 GAUGE STEEL (500,000 CYCLES)

18 & 16 GAUGE STEEL (1,000,000 CYCLES)

DOORS MEET LEED REQUIREMENTS AND BUY AMERICAN STANDARDS.

LABELING AGENCIES:
UNDERWRITES LABRATORY INC.
WARNOCK HERSEY INTL.
FACTORY MUTUAL SYSTEM

AVAILABLE IN:
14, 16, 18, 20
GAUGE
CR, A60



SUB-XX

DRAWN BY _____ DATE _____		ISSUE DATE	REVISIONS	BY
CHECKED _____ DATE _____				
SHT OF	JOB NO.			

① TOP CHANNELS

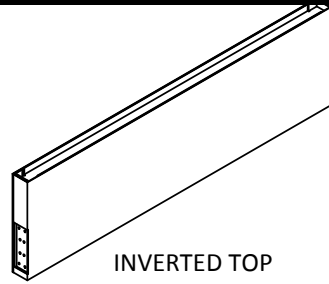
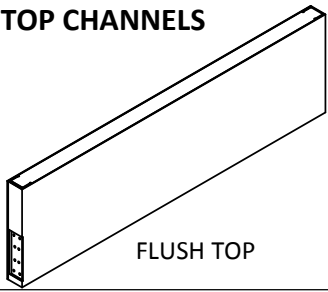

② CLOSER REINFORCEMENT

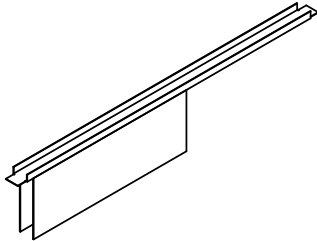

③ VERTICAL EDGE

STANDARD



NVS



④ HINGE PREP

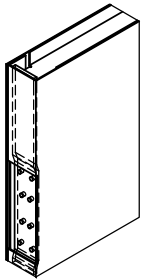

⑤ CORE

POLYSTRENE

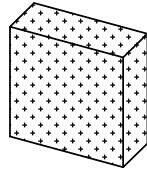

⑥ LOCK EDGE

BEVELED EDGE



SQUARE EDGE



⑦ LOCK PREP

FOR LOCK PREPS
SEE DOOR PREP PAGE

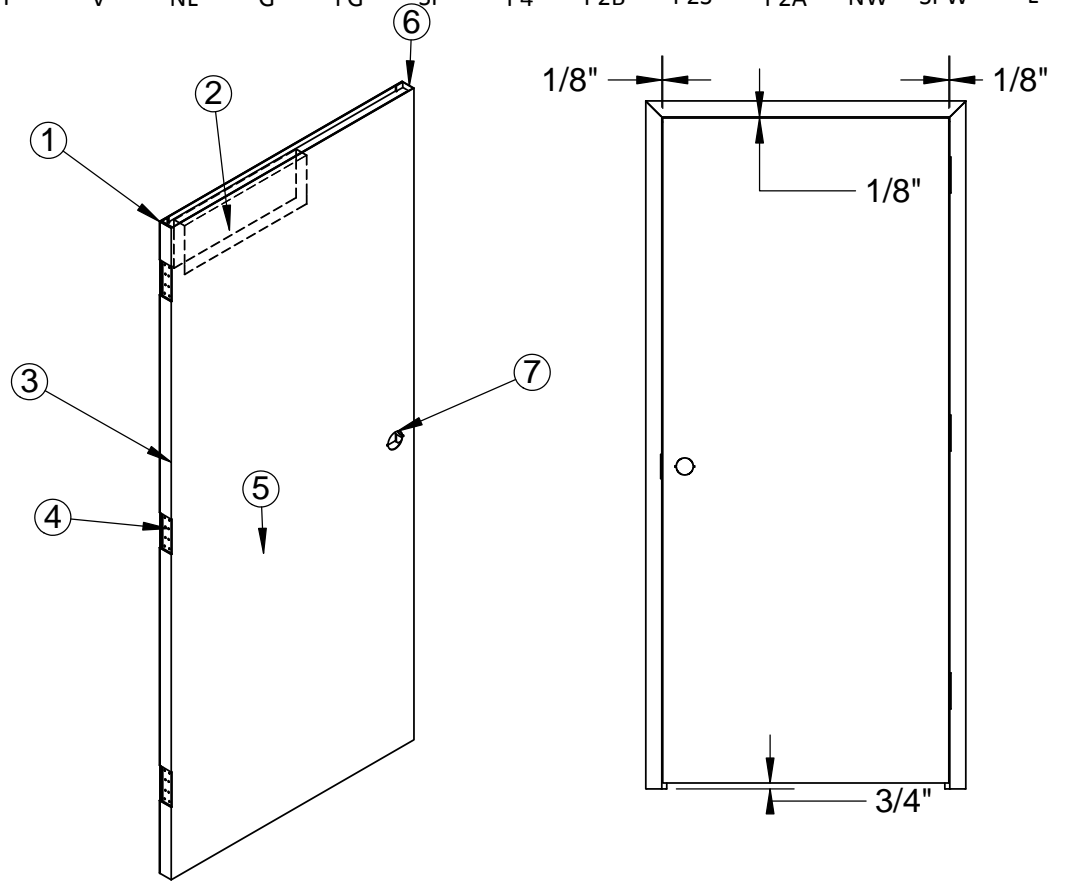
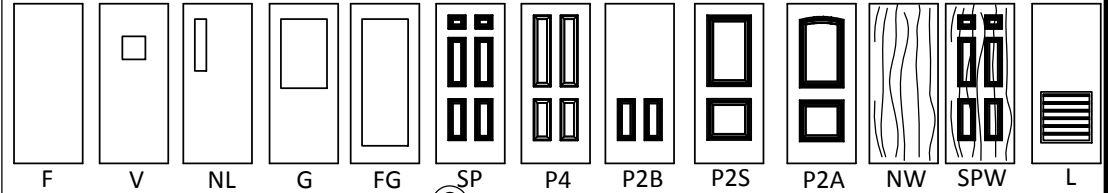

NP SERIES DOOR

DOOR MEETS OR EXCEEDS ANSI 250.4 PERFORMANCE TEST:

20 GAUGE STEEL (500,000 CYCLES)

18 & 16 GAUGE STEEL (1,000,000 CYCLES)

DOORS MEET LEED REQUIREMENTS AND BUY AMERICAN STANDARDS.

LABELING AGENCIES:
UNDERWRITES LABRATORY INC.
WARNOCK HERSEY INTL.
FACTORY MUTUAL SYSTEM

AVAILABLE IN:
14, 16, 18, 20
GAUGE
CR, A60



SUB-XX

DRAWN BY _____ DATE _____		ISSUE DATE	REVISIONS	BY
CHECKED _____ DATE _____				
SHT OF	JOB NO.			

① TOP CHANNELS

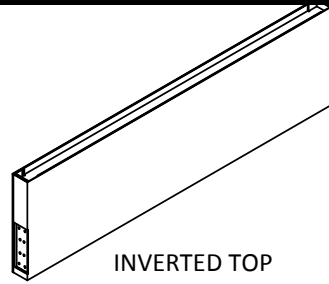
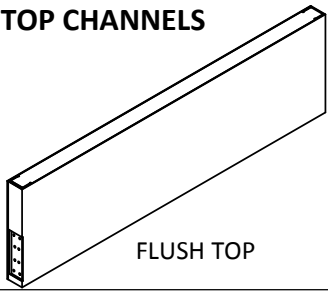

② CLOSER REINFORCEMENT

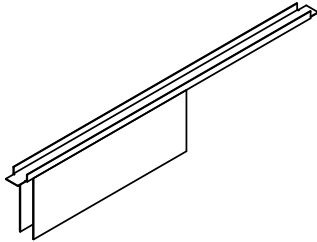

③ VERTICAL EDGE

STANDARD



NVS



④ HINGE PREP

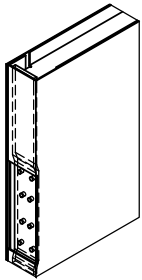

⑤ CORE

POLYURTHANE

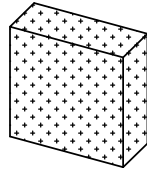

⑥ LOCK EDGE

BEVELED EDGE



SQUARE EDGE

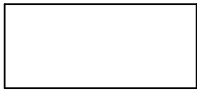

⑦ LOCK PREP

FOR LOCK PREPS
SEE DOOR PREP PAGE

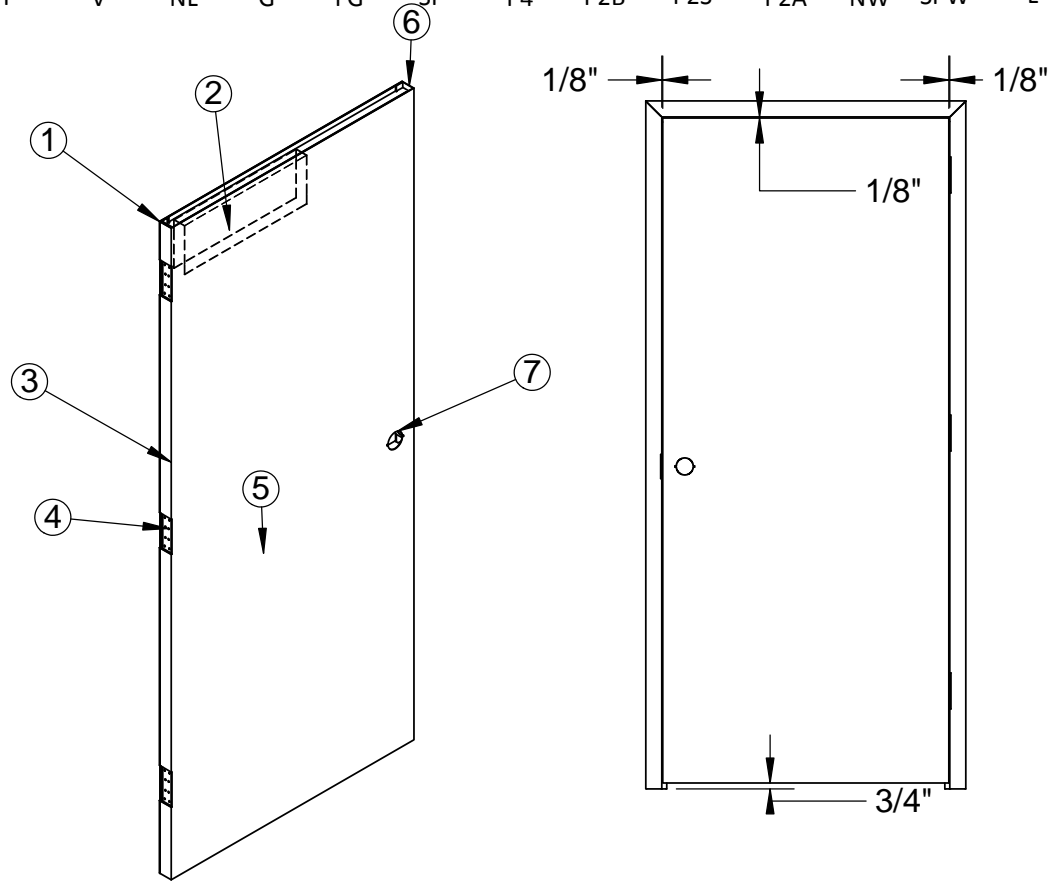
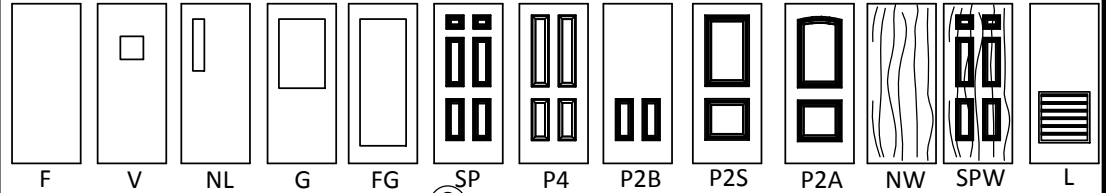

NU SERIES DOOR

DOOR MEETS OR EXCEEDS ANSI 250.4 PERFORMANCE TEST:

20 GAUGE STEEL (500,000 CYCLES)

18 & 16 GAUGE STEEL (1,000,000 CYCLES)

DOORS MEET LEED REQUIREMENTS AND BUY AMERICAN STANDARDS.

AVAILABLE IN:
14, 16, 18, 20
GAUGE
CR, A60



SUB-XX

DRAWN BY _____ DATE _____		ISSUE DATE	REVISIONS	BY
CHECKED _____ DATE _____				
SHT OF	JOB NO.			

PROFILES

DOUBLE RABBET TOGETHER

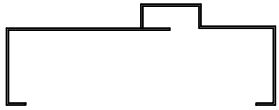

DOUBLE RABBET APART

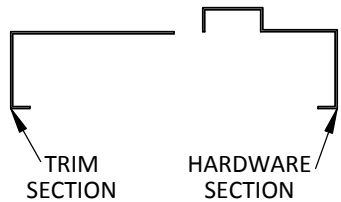

WELDING INFORMATION

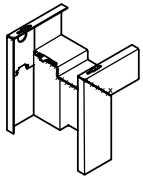

MUST BE FULL WELDED BEFORE INSTALLATION

HINGE SPACING

OPENING HEIGHT	6'8"			7'0"			7'2"			7'10"			8'0"		
	A	B	C	A	B	C	A	B	C	A	B	C	A	B	C
1 3/4" DOOR SPACING	7 1/4"	2@ 30 1/4"	12 1/4"	7 1/4"	2@ 32 1/4"	12 1/4"	7 1/4"	2@ 33 1/4"	12 1/4"	7 1/4"	3@ 25 1/4"	10 1/4"	7 1/4"	3@ 25 1/2"	12 1/4"
1 3/8" DOOR SPACING				6 3/4"	2@ 32 3/4"	11 3/4"	6 3/4"	2@ 33 3/4"	11 3/4"						

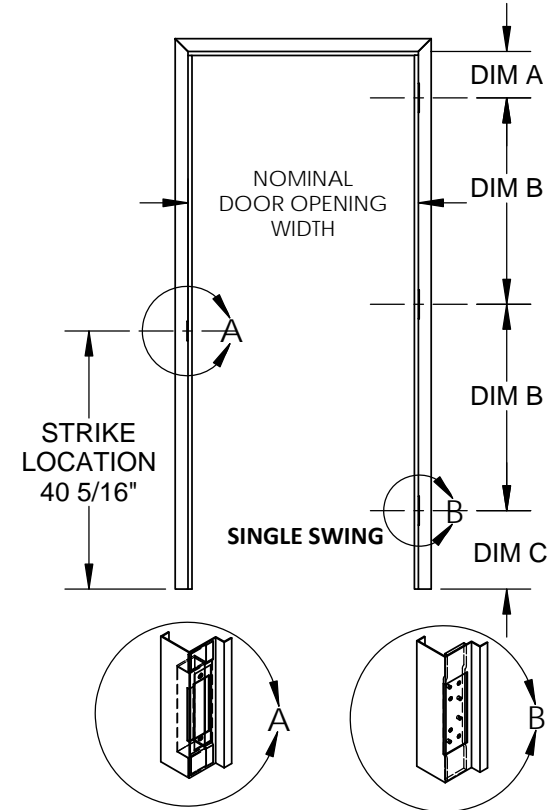
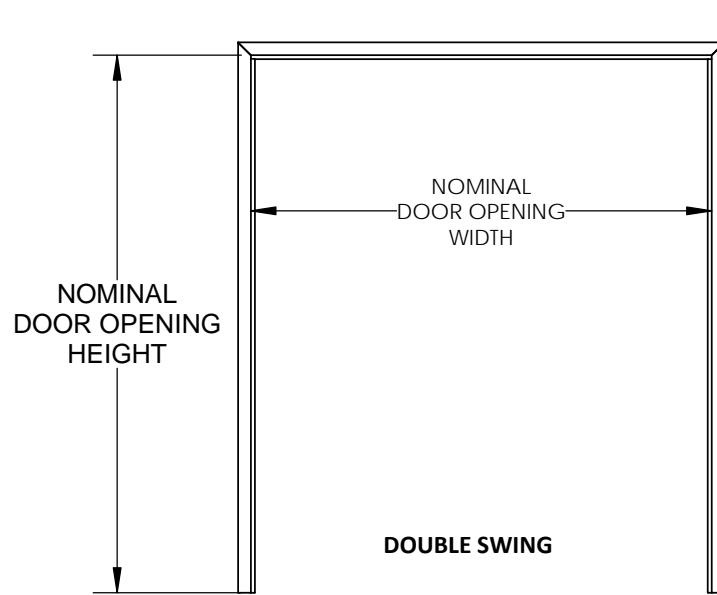

RF SERIES FRAMES

RF SERIES FRAMES ARE AVAILABLE AS SHOWN FOR THREE SIDED FRAMES OR AS STICK SECTIONS FOR TRANSOMS, SIDELIGHTS AND BORROWED LITE FRAMES.

FOR LABELING DETAILS, ANCHORING OPTIONS, AND DOOR HANDING & SWING, PLEASE SEE THE APPLICABLE SECTION OF THE TECHNICAL DATA MANUAL.



SUB-XX

DRAWN BY _____ DATE _____		ISSUE DATE	REVISIONS	BY
CHECKED _____ DATE _____				
SHT OF	JOB NO.			

① TOP CHANNELS

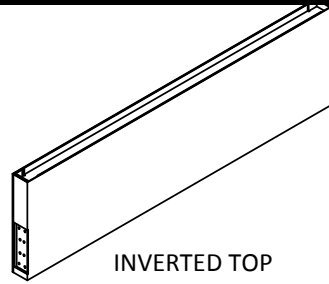
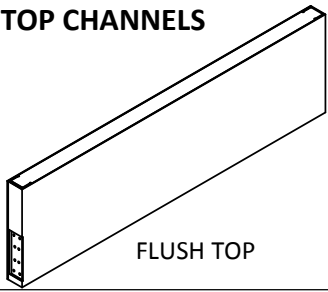

② CLOSER REINFORCEMENT

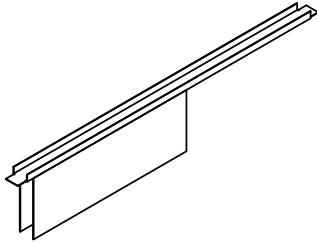

③ VERTICAL EDGE

STANDARD



NVS



④ HINGE PREP

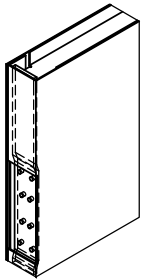

⑤ CORE

POLYSTRENE

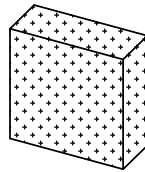

⑥ LOCK EDGE

BEVELED EDGE



SQUARE EDGE



⑦ LOCK PREP

FOR LOCK PREPS
SEE DOOR PREP PAGE

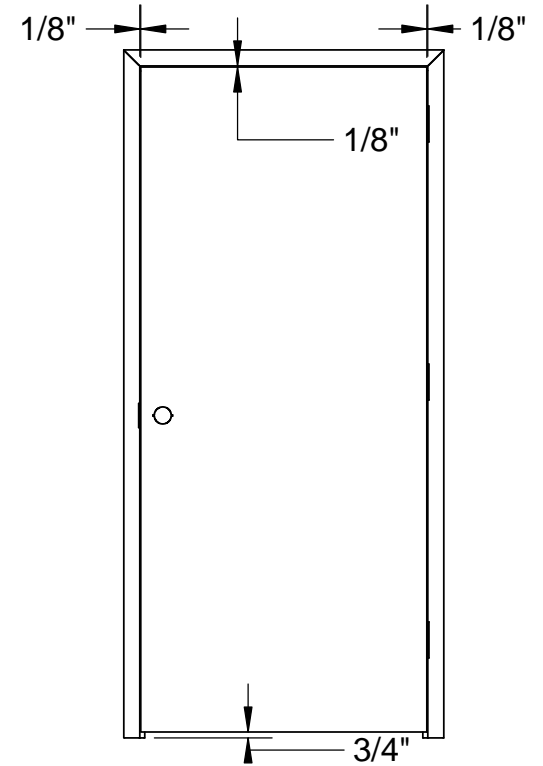
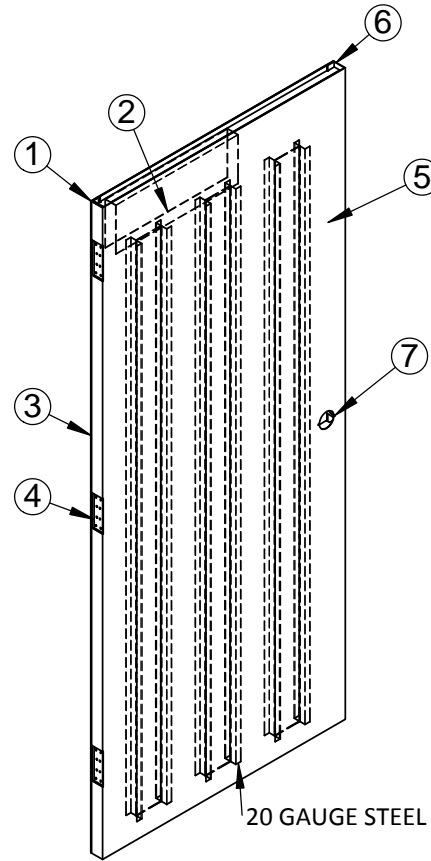
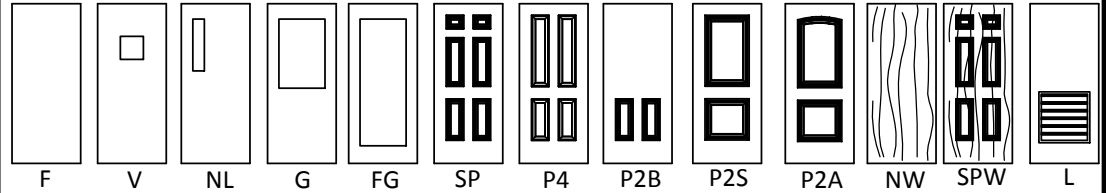

20 GAUGE STEEL STIFFENER WELED EVERY 6"

ST SERIES DOOR

DOOR MEETS OR EXCEEDS ANSI 250.4 PERFORMANCE TEST:

20 GAUGE STEEL (500,000 CYCLES)

18 & 16 GAUGE STEEL (1,000,000 CYCLES)

DOORS MEET LEED REQUIREMENTS AND BUY AMERICAN STANDARDS.

LABELING AGENCIES:
UNDERWRITES LABRATORY INC.
WARNOCK HERSEY INTL.
FACTORY MUTUAL SYSTEM

AVAILABLE IN:
14, 16, 18, 20
GAUGE
CR, A60



SUB-XX

DRAWN BY _____ DATE _____		ISSUE DATE	REVISIONS	BY
CHECKED _____ DATE _____				
SHT OF	JOB NO.			